

FITTING INSTRUCTION

Clamp mark in acc. with		Cables joining
ISO	PN	
1	L	Left directional lights
2	+	Rear fog lights
3	31	Ground
4	R	Right directional lights
5	58R	Right side parking lights
6	54	Stoplights
7	58L	Left side parking lights

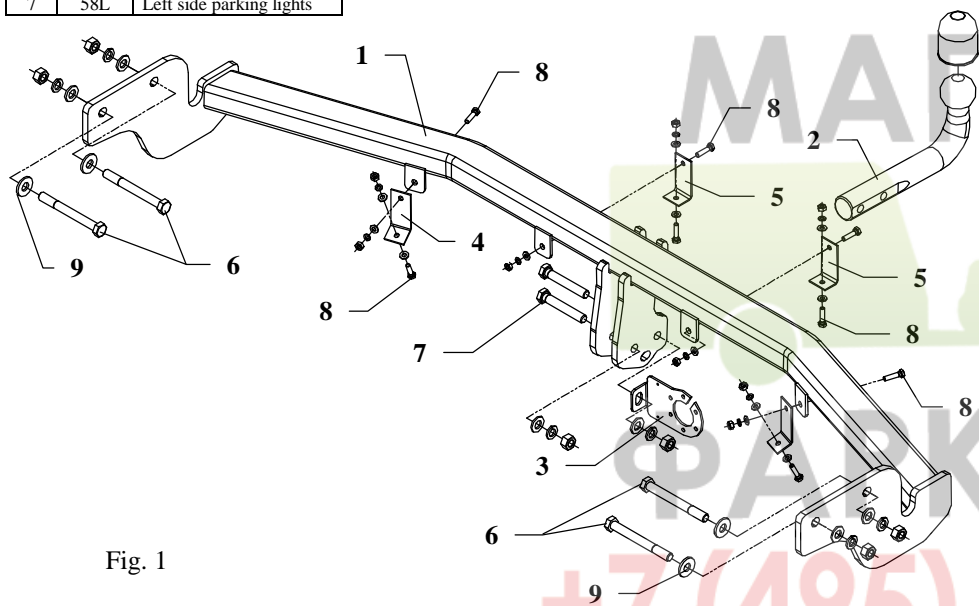

Fig. 1

This towing hitch is designed to assembly in following cars:
HYUNDAI SANTA FE, produced since 2006, catalogue no. **J54** and is prepared to tow trailers max total weight **2200 kg** and max vertical load **88 kg**.

From manufacturer

Thank you for buying our product. Their reliability has been confirmed in many tests. Reliability of towing hitch depends also on correct assembly and right operation. For this reasons we kindly ask to read carefully this instruction and apply to hints.

The towing hitch should be install in points described by a car producer.

The instruction of the assembly

1. Unscrew the bumper along with the metal-reinforcement and foam fulfilment (the metal-reinforcement and the fulfilment will not be assembled again).
2. Lower mufflers from rear handles.
3. Unscrew thermal shields.
4. Apply the main bar of the towing hitch (pos. 1) to chassis members in that way so holes in the main bar be covered with holes in the frame, then fix using bolts M12x110mm (pos. 6). Use large washers (pos. 9).
5. Install thermal shield and hang up mufflers.
6. Cut out fragment of the bumper (as shown in the fig. 2), then install the bumper. Use handles (pos. 4 and 5) from the towing hitch accessories (see fig. 1).

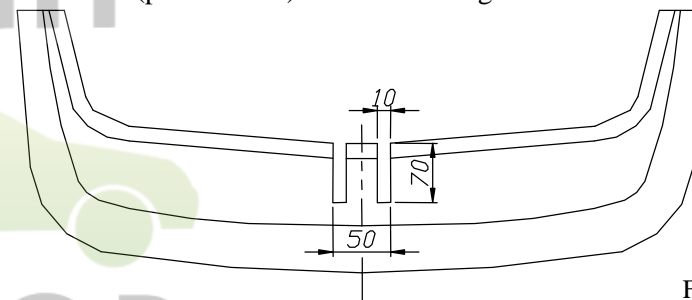

Fig. 2

7. Fix tow-ball (pos. 2) with socket plate (pos. 3) using bolts M12x75mm (pos. 7) from accessories.
8. Tighten all bolts according to the torque shown in the table.
9. Connect electric wires of 7-poles socket according to the instruction of the car. (Recommend to make at authorized service station).
10. Complete paint layer damaged during installation.

Torque settings for nuts and bolts (8,8):	
M 8 - 25 Nm	M 10 - 55 Nm
M 12 - 85 Nm	M 14 - 135 Nm











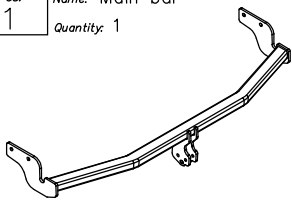

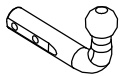
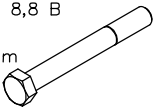
NOTE

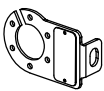
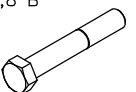
After install the towing hitch you should get adequate note in registration book (at authorised service station).The car should be equipped with:

- Indicators
- Tow mirrors

After 1000km check all screws. The ball of towing hitch must be always kept clear and conserve with a grease.

Towing hitch accessories:

Pos. 1 Name: Main bar Quantity: 1	Pos. 5 Name: Handle II Quantity: 2	Pos. 11 Name: Nut 8 B Quantity: 8 Dim.: M6
		
Pos. 2 Name: Tow ball Quantity: 1	Pos. 6 Name: Bolt 8,8 B Quantity: 4 Dim.: M12x110mm	Pos. 12 Name: Plain washer Quantity: 6 Dim.: Ø 13 mm
		
Pos. 3 Name: Socket plate Quantity: 1	Pos. 7 Name: Bolt 8,8 B Quantity: 2 Dim.: M12x75mm	Pos. 13 Name: Plain washer Quantity: 12 Dim.: Ø 6,4 mm
		
Pos. 4 Name: Handle I Quantity: 2	Pos. 8 Name: Bolt 8,8 B Quantity: 8 Dim.: M6x25mm	Pos. 14 Name: Spring washer Quantity: 6 Dim.: Ø 12,2 mm
		
Pos. 9 Name: Washer Quantity: 4 Dim.: Ø29xØ13x3mm	Pos. 10 Name: Nut 8 B Quantity: 6 Dim.: M12	Pos. 15 Name: Spring washer Quantity: 8 Dim.: Ø 6,1 mm
		
Pos. 16 Name: Ball cover Quantity: 1		
		



PPUH AUTO-HAK S.J.

Produkcja Haków Holowniczych
Henryk & Zbigniew Nejman
76-200 SŁUPSK ul. Słoneczna 16K
tel/fax (059) 8-414-414; 8-414-413
E-mail: office@autohak.com.pl
www.autohak.com.pl

Towing hitch (without electrical set)

Class: A50-X Cat. no. J54

Designed for:

Manufacturer: **HYUNDAI**

Model: **SANTA FE**

produced since 2006

Technical data:

D-value: 11,6 kN

maximum trailer weight: **2200 kg**

maximum vertical cup load: **88 kg**

Approval number according to Directive 94/20/EC: **e20*94/20*0120*00**

Foreword

This towing hitch is designed according to rules of safety traffic regulations. The towing hitch is a safety component and can be install only by qualified personnel. Any alteration or conversion of the towing hitch is prohibited and would lead to cancellation of design certification. Remove insulating compound and underseal from vehicle (if present) in the area of the matting surfaces of the towing hitch. The vehicle manufacturer's specifications regarding trailer load and max. vertical cup load are decisive for driving whereat values for the towing hitch cannot be exceeded.

D-value formula:

$$\frac{\text{Max trailer weight [kg]} \times \text{Max vehicle weight [kg]}}{\text{Max trailer weight [kg]} + \text{Max vehicle weight [kg]}} \times \frac{9,81}{1000} = D \text{ [kN]}$$